

# MINI-360

MP2307 Buck Converter

## Features

- Input voltage: 4.75-23V
- Output voltage: 1-17V, adjustable
- Size: 17mm x 11mm x 4mm
- Max. output current: 1.8A

## Additional information

- Starts working at about 5 V input
- 4-15mA idle current
- Adjusting the voltage is very fiddly
- The output voltage needs to be at least 2V below the input voltage
- MP2307DN buck converter chip
- No thermal vias under the switching the IC

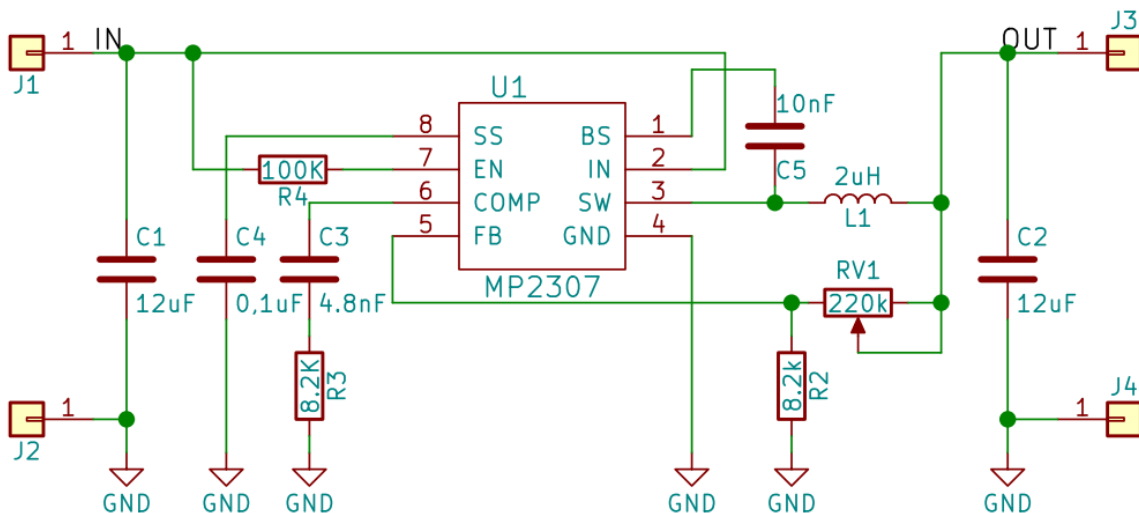
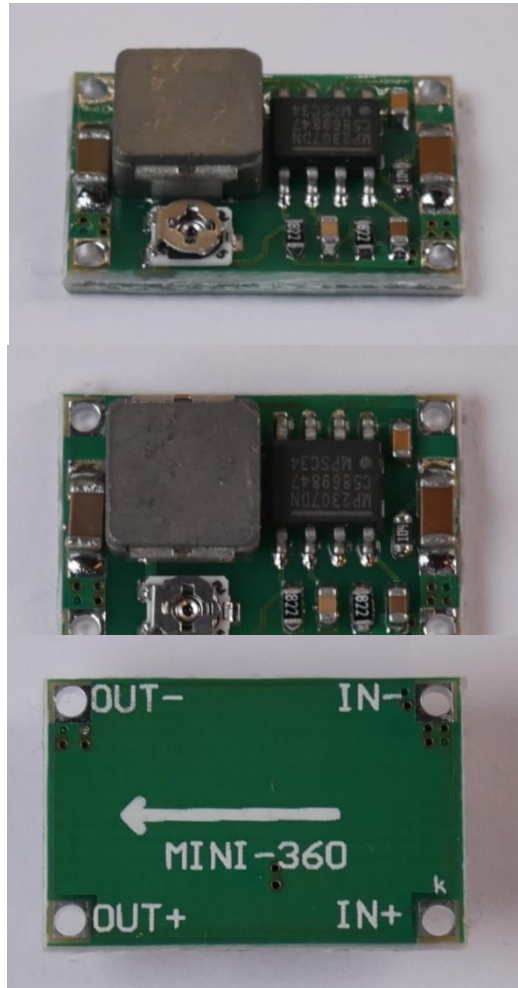

# MINI-360

MP2307 Buck Converter

## Efficiency

### 3.3V Output

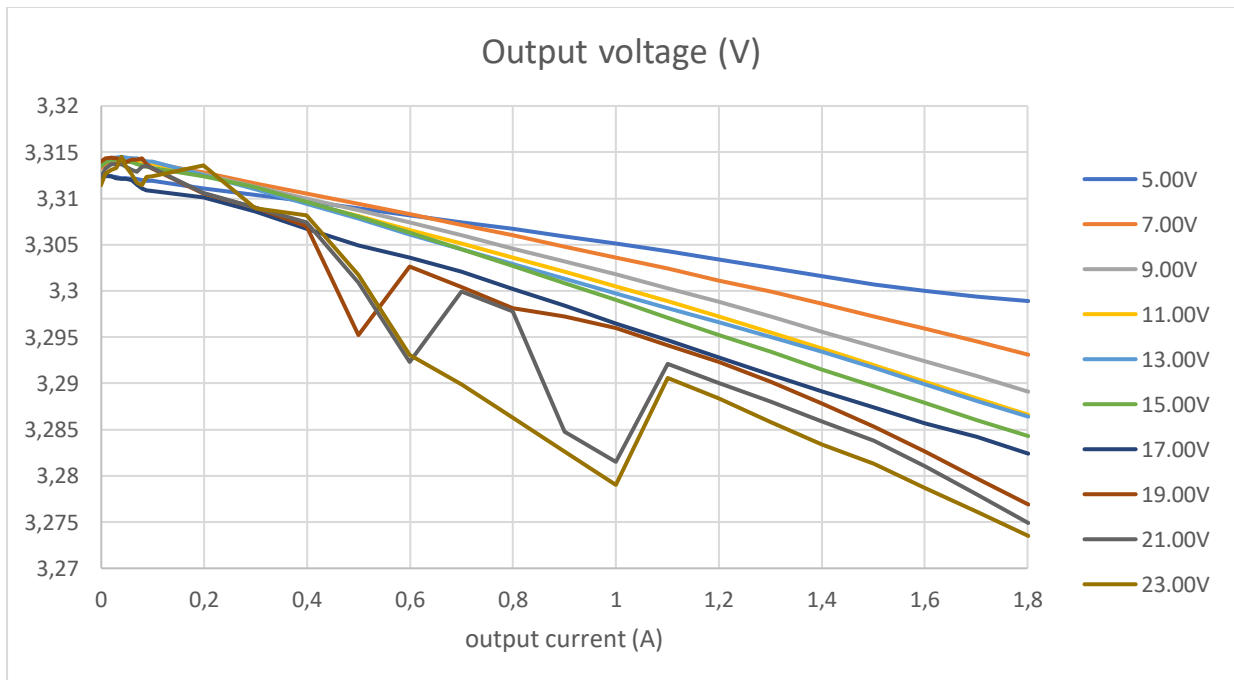
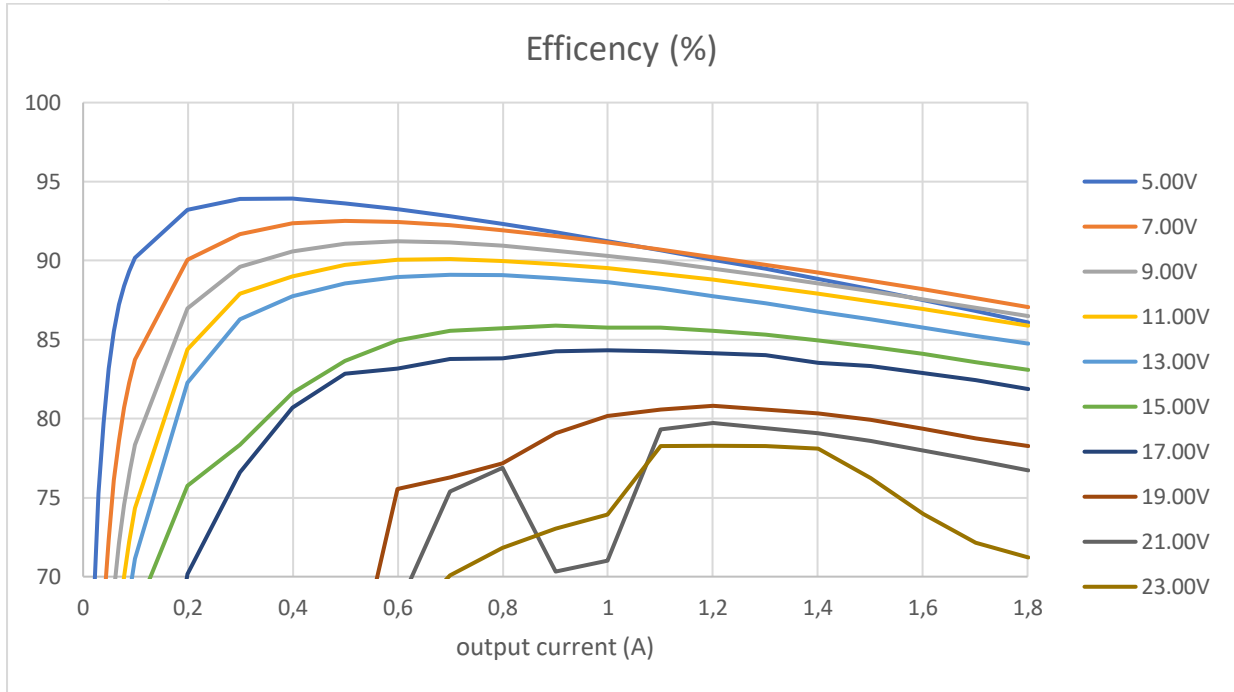

# MINI-360

MP2307 Buck Converter

## 5V Output

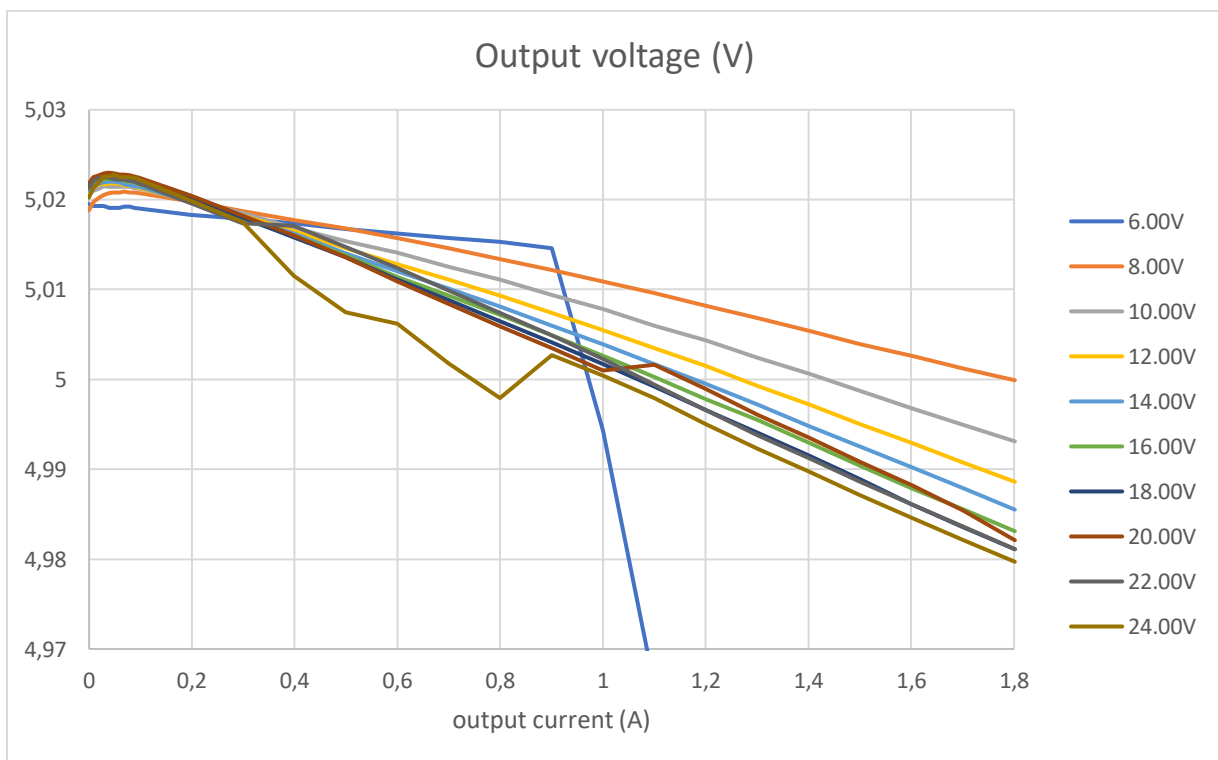
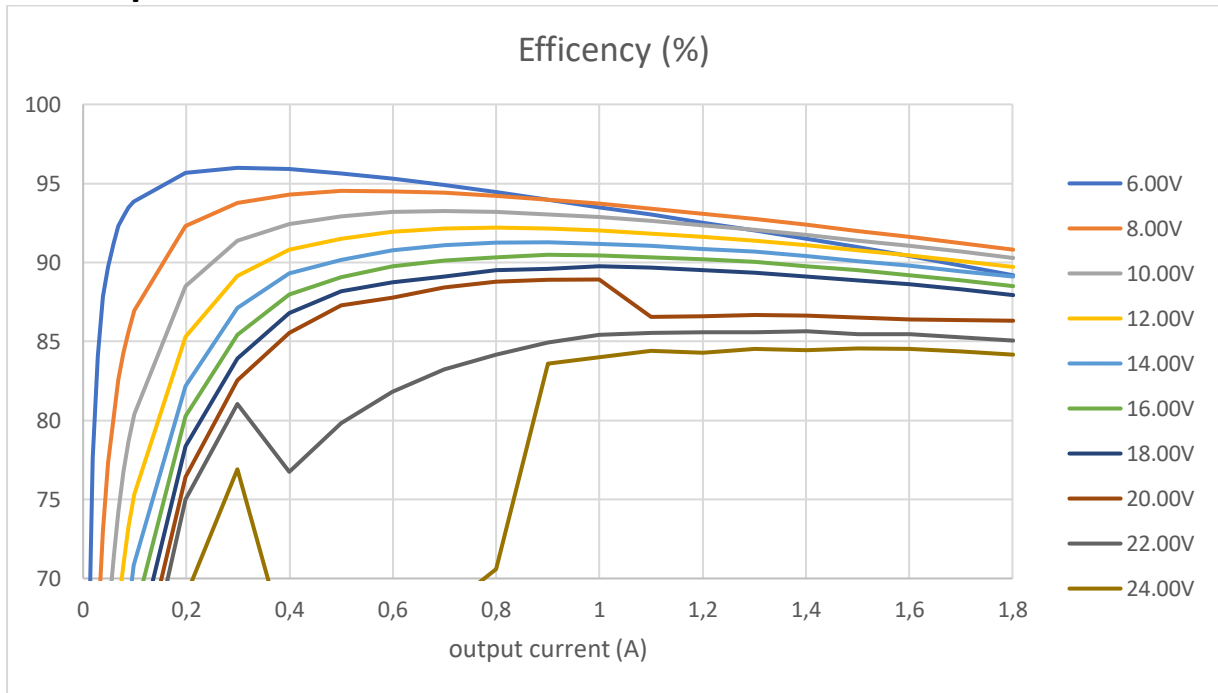

# MINI-360

MP2307 Buck Converter

## 9V Output

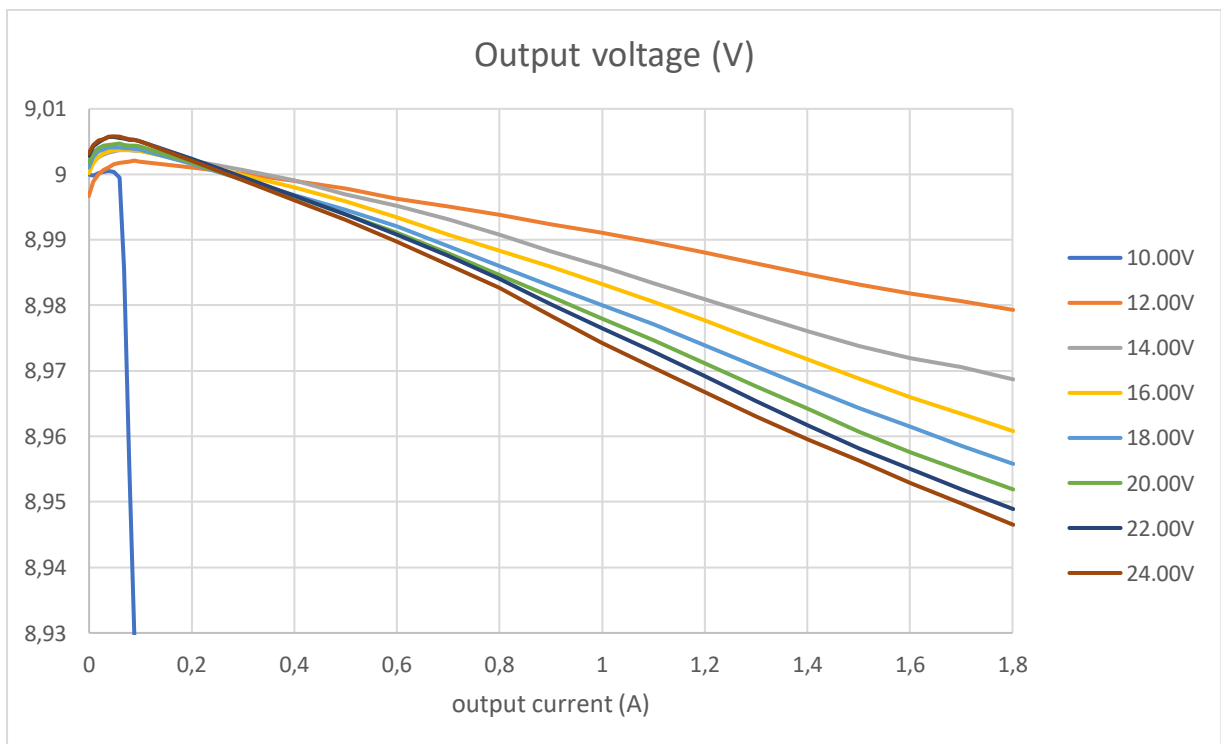
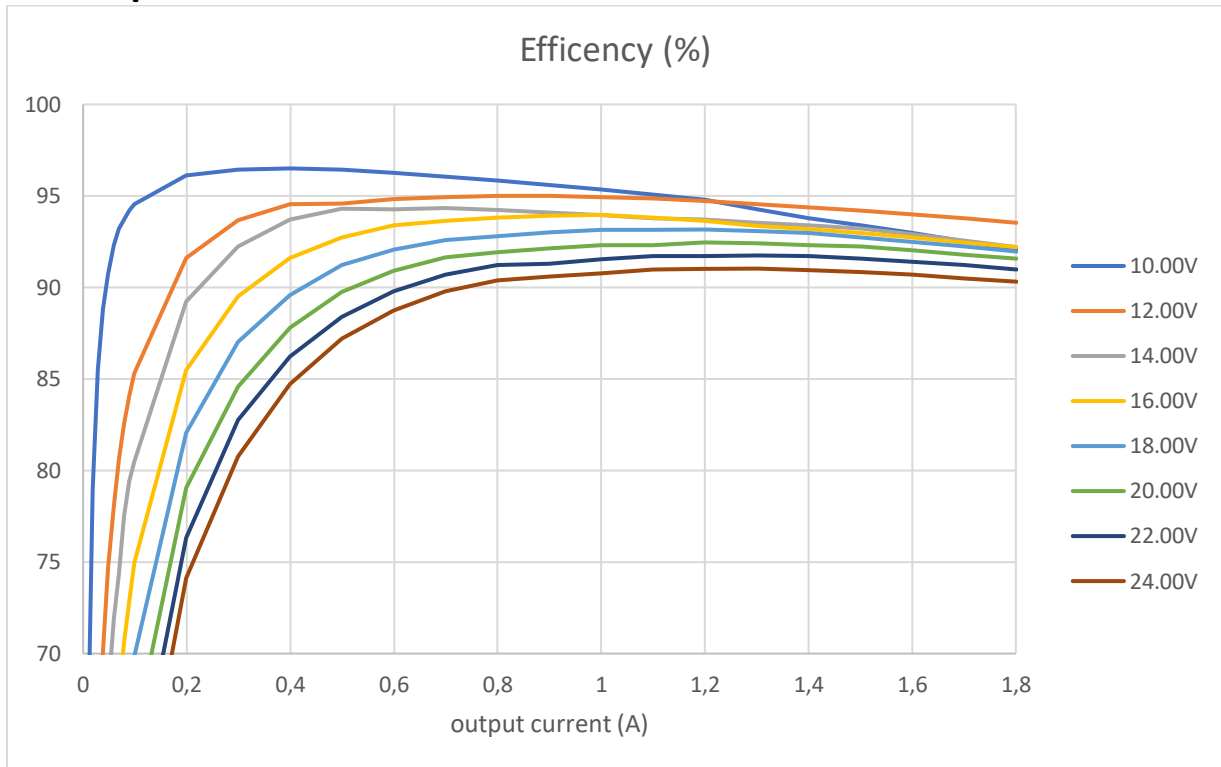

# MINI-360

MP2307 Buck Converter

## 12V Output

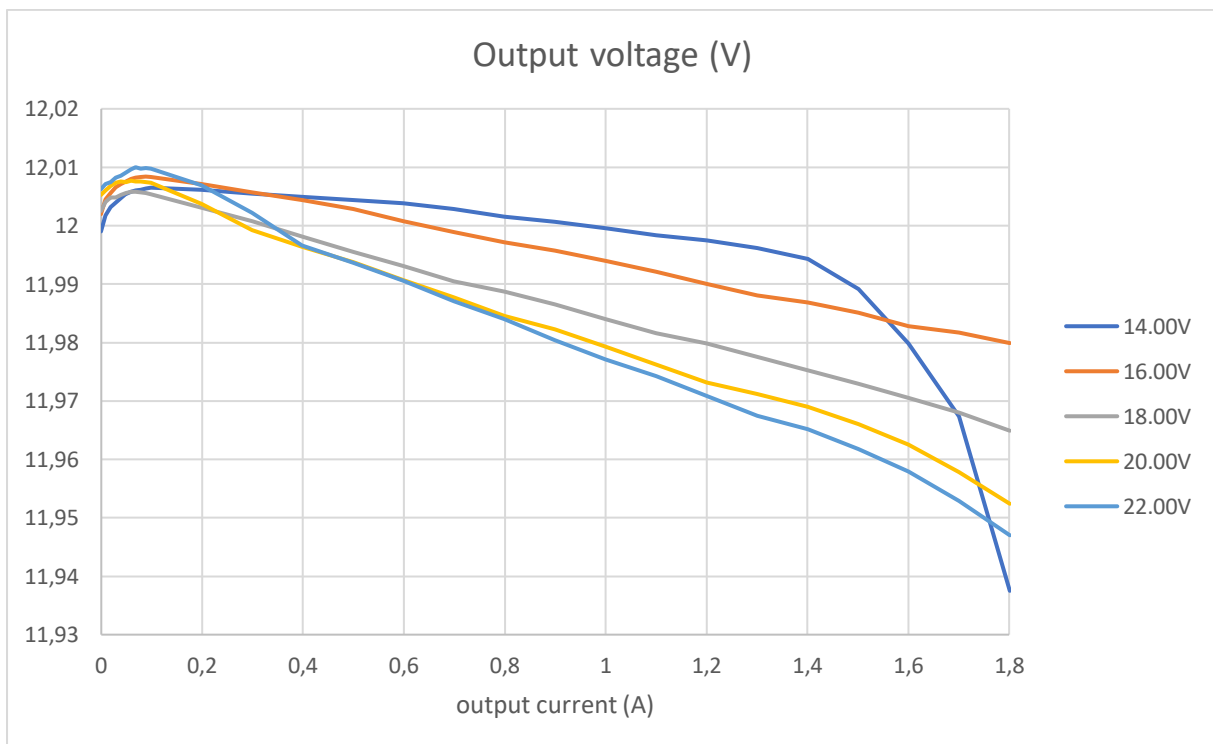
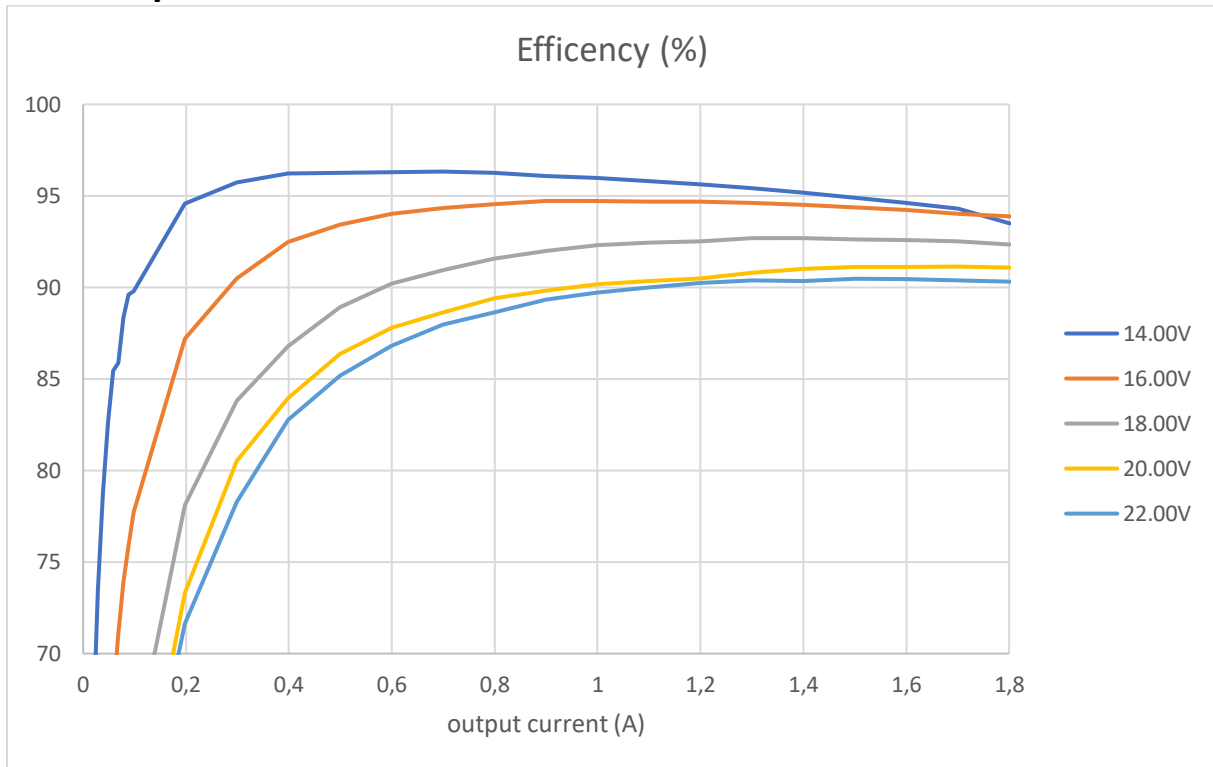

# MINI-360

MP2307 Buck Converter

## 15V Output

